

DS-D5A86RB/A

Interactive Tablet

The Interactive tablet (hereafter referred to as the “device”) integrates functions of computers, projectors, interactive whiteboards, sound boxes, cameras (optional), HDTVs, advertising machines and so on. The device integrates technologies like 4K display, infrared touch, human-machine interaction, multi-media information processing, and network transmission and provides users with various features such as writing, annotating, multi-screen sharing, and remote video call (optional).

The Interactive tablet is mainly used for remote video conferences, trainings and guidance, medical consulting, and other events in kinds of offices, meeting rooms, multi-media classrooms, exhibition halls and so on.



Key Features

- 4K display, and the resolution of the input signal is up to 3840 × 2160.
- 20px ultra fine writing, and 1 mm writing in diameter recognizable.
- Built-in Wi-Fi realizes wireless screen mirroring without any cable connection.
- Built-in interactive whiteboard system allows annotating and sharing by scanning QR code.
- Display looping out.
- Various audio and video interfaces for device access.
- Built-in network switch chip saves a network switch.
- Built-in Android system supports kinds of applications.
- Compatible with OPS/OPS-C devices, and built-in systems can seamlessly switch between each other.
- Ultrathin aluminum profile frame design.



Specifications

Model		DS-D5A86RB/A	
Screen	Diagonal Screen Size	86"	
	Backlight	LED Backlight	
	Resolution	3840 × 2160 @60 Hz	
	Display Scale	16:9	
	Pixel Pitch	0.4935(H) × 0.4935(V) mm	
	Color	10 bit	
	Brightness	350 cd/m ²	
	Contrast	1200: 1	
	Response Time	8 ms	
	Viewing Angle	Horizontal 178°, vertical 178°	
Interface	HDMI IN	2, Max. 4K@30Hz	
	HDMI Out	1, Max. 4K@60Hz	
	VGA In	1, Max. 1080P@60Hz	
	Audio In	2	
	Audio Out	2	
	USB Interface	2 USB on front panel , 2 USB on side panel	
	RJ45 (100Mbps ports)	2	
General	Power Supply	100 V to 240 VAC, 50/60 Hz	
	Power Consumption	< 600 W	
	Net Weight	77.760 kg	
	Gross Weight (with package)	100.760 kg	
	Product Dimensions (Width × Height × Thickness)	1990 × 1186 × 118 mm	
	Package Dimensions (Width × Height × Thickness)	2205 × 1413 × 315 mm	
	Working Temperature	0°C to 40°C	
	Working Humidity	10% to 90%	
	Built-in System	CPU	4-core Cortex-A53, 1.5 GHz
		Memory	2 GB

	Storage	32 GB
	NIC	Built-in 100Mbps NIC, supporting routing
	Speaker	Built-in 16 W speaker × 2
	Decoding	H.265/H.264, 4K@60 × 1
	Operation System	Android 5.0

Available Models

DS-D5A86RB/A

Physical Interface

Bottom interfaces of the rear panel:

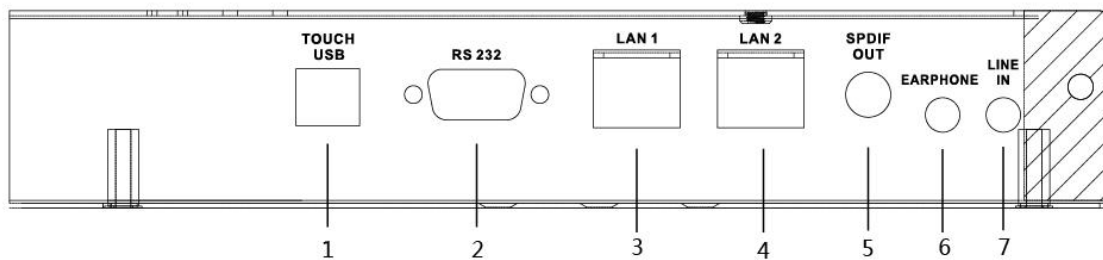

Interface	Description	Interface	Description
1.TOUCH-USB	Peripheral Touch Interface	2.RS-232	RS-232 Serial Port
3.LAN 1	Ethernet Interface 1	4. LAN 2	Ethernet Interface 2
5.SPDIF OUT	Digital Multi-media Speaker Interface	6.EARPHONE	Earphone Interface
7.LINE IN	Audio Input Interface	---	---

Left interfaces of the rear panel:

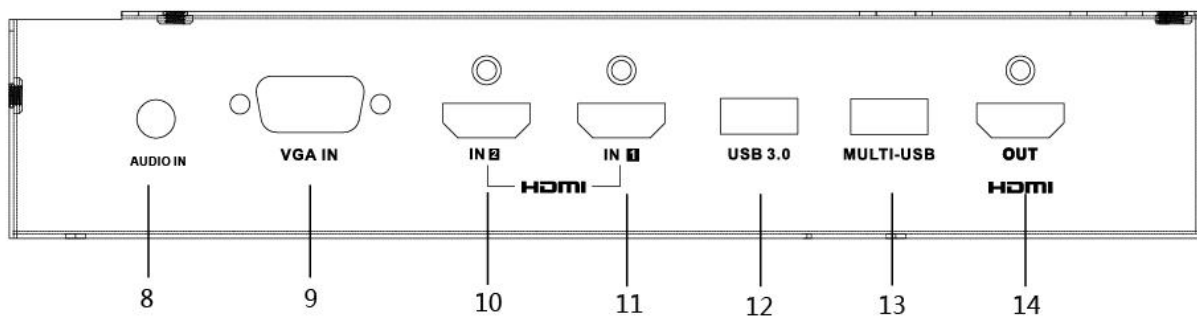

Interface	Description	Interface	Description
8.AUDIO IN	Audio Input Interface	9.VGA IN	VGA Input Interface
10.HDMI IN2	HDMI2 Input Interface	11.HDMI IN1	HDMI1 Input Interface
12.USB 3.0	USB 3.0 Interface	13.MULTI-USB	Multi-function USB Interface
14.HDMI OUT	HDMI Output Interface	---	---

Dimensions (unit: mm)

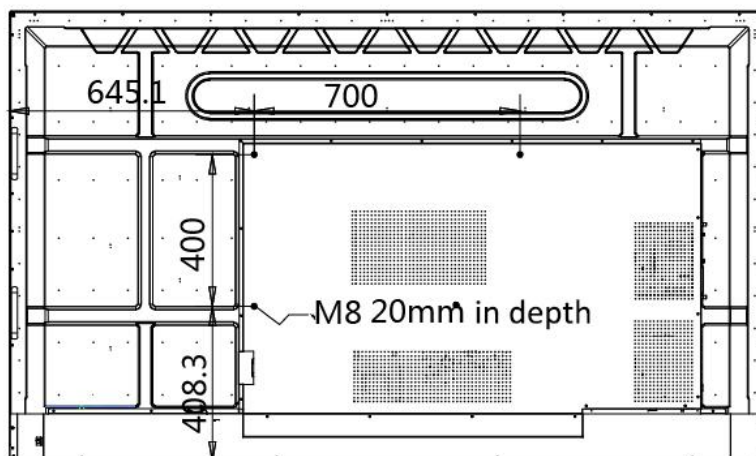
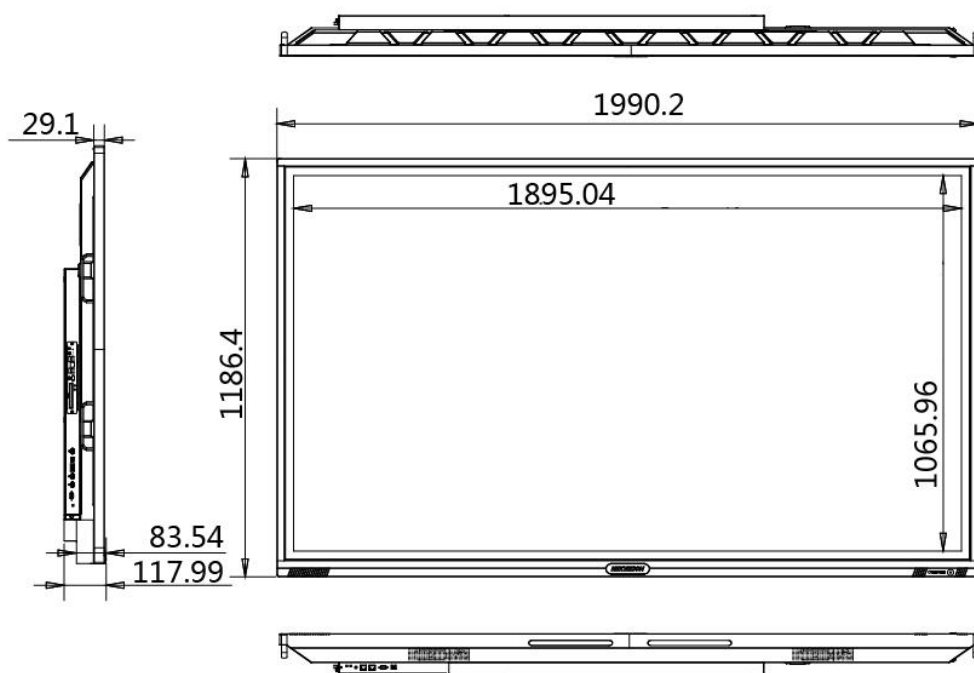

Mounting Method

Wall mounting

The rear should be installed on the hook holes

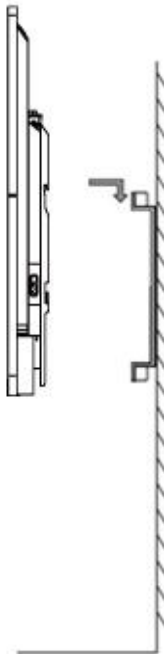
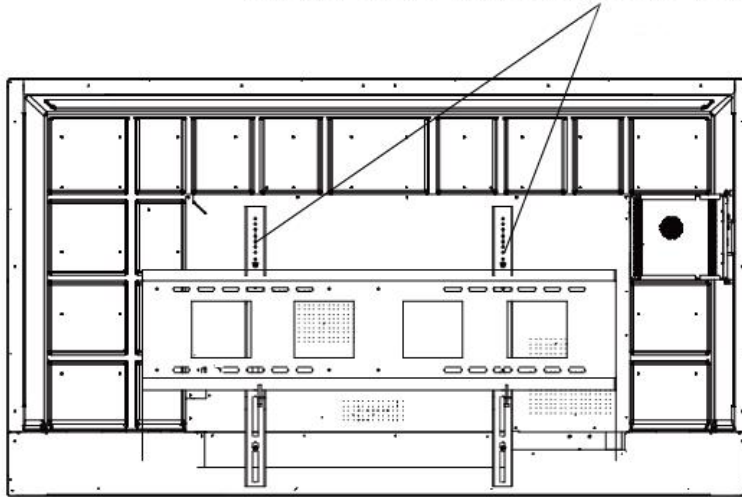

 **NOTE**

The bracket for wall mount can be moved horizontally. Please leave a space no less than 6 cm at each side, or a space no less than 12 cm at one side for maintenance service.

Mobile Mounting

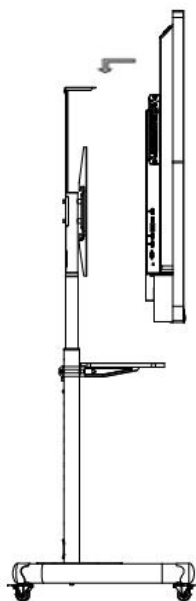

Distributed by



HIKVISION®

Headquarters

No.555 Qianmo Road, Binjiang District,
Hangzhou 310051, China
T +86-571-8807-5998
overseasbusiness@hikvision.com

Hikvision USA
T +1-909-895-0400
sales.usa@hikvision.com

Hikvision Australia
T +61-2-8599-4233
salesau@hikvision.com

Hikvision India
T +91-22-28469900
sales@pramahikvision.com

Hikvision Canada
T +1-866-200-6690
sales.canada@hikvision.com

Hikvision Thailand
T +662-275-9949
sales.thailand@hikvision.com

Hikvision Europe
T +31-23-5542770
sales.eu@hikvision.com

Hikvision Italy
T +39-0438-6902
info.it@hikvision.com

Hikvision Brazil
T +55 11 3318-0050
Latam.support@hikvision.com

Hikvision Turkey
T +90 (216)521 7070- 7074
sales.tr@hikvision.com

Hikvision Malaysia
T +601-7652-2413
sales.my@hikvision.com

Hikvision UK & Ireland
T +01628-902140
sales.uk@hikvision.com

Hikvision South Africa
Tel: +27 (10) 0351172
sale.africa@hikvision.com

Hikvision France
T +33(0)1-85-330-450
info.fr@hikvision.com

Hikvision Kazakhstan
T +7-727-9730667
nikia.panfilov@hikvision.ru

Hikvision Vietnam
T +84-974270888
sales.vt@hikvision.com

Hikvision UAE
T +971-4-4432090
salesme@hikvision.com

Hikvision Singapore
T +65-6684-4718
sg@hikvision.com

Hikvision Spain
T +34-91-737-16-55
info.es@hikvision.com

Hikvision Tashkent
T +99-87-1238-9438
uzb@hikvision.ru

Hikvision Hong Kong
T +852-2151-1761
info.hk@hikvision.com

Hikvision Russia
T +7-495-669-67-99
saleru@hikvision.com

Hikvision Korea
T +82-[0]31-731-8817
sales.korea@hikvision.com

Hikvision Poland
T +48-22-460-01-50
info.pl@hikvision.com

Hikvision Indonesia
T +62-21-2933759
Sales.Indonesia@hikvision.com

Hikvision Colombia
sales.colombia@hikvision.com